

TCL

The Creative Life

User's Guide

For use with models: LE50FHDE3010
/ LE58FHDE3010





*Need assistance?
visit our website at www.tclusa.com
or call 1-877-300-8837*

COLOR YOUR WORLD

The background features three stylized water splashes. Each splash is rendered with a complex, low-poly geometric pattern in shades of gray and black, giving them a crystalline or digital appearance. The splashes are positioned in the lower half of the page, with one at the bottom left, one in the middle right, and one at the top right.

Figures and illustrations in this User's Guide are provided for reference only and may differ from actual product appearance. Product design and specifications may be changed without notice.

Important Information

	CAUTION RISK OF ELECTRIC SHOCK. DO NOT OPEN.		 This symbol indicates that this product incorporates double insulation between hazardous main voltage and user accessible parts. When servicing, use only identical replacement parts.
Caution: To reduce the risk of electric shock, do not remove cover (or back). No user serviceable parts inside. Refer servicing to qualified service personnel.			
	This symbol indicates "dangerous voltage" inside the product that presents a risk of electric shock or personal injury.		This symbol indicates important instructions accompanying the product.

WARNING

To reduce the risk of fire or electric shock, do not expose this product to rain or moisture. This product should not be exposed to dripping or splashing. No objects filled with liquids, such as vases, should be placed on the component.

WARNING

The TV is unstable if it is not properly attached to the base or mounted to the wall. Please follow the base or wall mounting instructions provided in the User's Guide to ensure your safety.

WARNING The batteries shall not be exposed to excessive heat such as sunshine, fire or the like.

Refer to the identification/rating label located on the back panel of your product for its proper operating voltage. FCC regulations state that unauthorized changes or modifications to this equipment may void the user's authority to operate it.

Cable TV Installer: This reminder is provided to call your attention to Article 820-40 of the National Electrical Code (Section 54 of the Canadian Electrical Code, Part 1) which provides guidelines for proper grounding and, in particular, specifies that the cable ground should be connected to the grounding system of the building as close to the point of cable entry as practical.

Important: This television is a table model and is designed to sit on a firm, flat surface. Don't place the TV on soft carpeting or similar surface because the ventilation slots on the bottom of the unit will be blocked, resulting in reduced lifetime from overheating. To assure adequate ventilation for this product, maintain a spacing of 4 inches from the top and side of the TV receiver and 2 inches from the rear of the TV receiver and other surfaces.

Also, make sure the stand or base you use is of adequate size and strength to prevent the TV from being accidentally tipped over, pushed off, or pulled off. This could cause personal injury and/or damage to the TV. Refer to the Important Safety Instructions on the next page.

The Power button (followed by the power symbol) on this TV and your remote control puts the TV into a very low-power standby mode but will not completely turn the power off. In order to completely shut the power off, you will need to disconnect the power cord from the outlet. The mains plug/appliance coupler is used as disconnect device, the disconnect device shall remain readily operable. Therefore, you should ensure that the TV is installed in a manner that allows you to disconnect the power cord when desired.

Product Registration

Please register your TCL purchase on-line at www.tclusa.com. It will make it easier to contact you should it ever be necessary. Registration is not required for warranty coverage.

Product Information

Keep your sales receipt to obtain warranty parts and service and for proof of purchase. Attach it here and record the serial and model numbers in case you need them. These numbers are located on the product.

Model No. _____ **Serial No.** _____
Purchase Date _____ **Dealer/Address/Phone** _____

Important Safety Instructions

1. Read and follow all instructions.
2. Keep these instructions.
3. Heed all warnings.
4. Do not block any ventilation openings. Install in accordance with the manufacturer's instructions.
5. Do not install near any heat sources such as radiators, heat registers, stoves, or other apparatus (including amplifiers) that produce heat.
6. Protect the power cord from being walked on or pinched particularly at plugs, receptacles, and the point where it exits from the component.
7. Do not use this component near water.
8. Only use the attachments/accessories specified by the manufacturer.
9. Clean only with dry cloth.
10. Use only with the cart, stand, tripod, bracket, or table specified by the manufacturer, or sold with the component. When the TV is placed on a cart, use caution when moving the cart to avoid injury from tip-over.
11. Warning: To avoid any injury caused by lean of the product, please always ensure the whole product was place within the table surface in horizontal.
12. Unplug this component during lightning storms or when unused for long periods of time.
13. Refer all servicing to qualified service personnel. Service is required when the component is damaged in any way, such as power supply cord or plug damage, liquid spilled on or objects falling onto the component, rain or moisture exposure, abnormal operation, or if the component has been dropped.
14. If an outside antenna or cable system is connected to the product, be sure the antenna or cable system is grounded so as to provide some protection against voltage surges and built-up static charges. Section 810 of the National Electrical Code, ANSI/NFPA No. 70-1984 (Section 54 of Canadian Electrical Code, Part 1) provides information with respect to proper grounding of the mast and supporting structure, grounding of the lead-in wire to an antenna-discharge unit, size of grounding conductors, location of antenna-discharge unit, connection to grounding electrodes, and requirements for the grounding electrode. See following example:

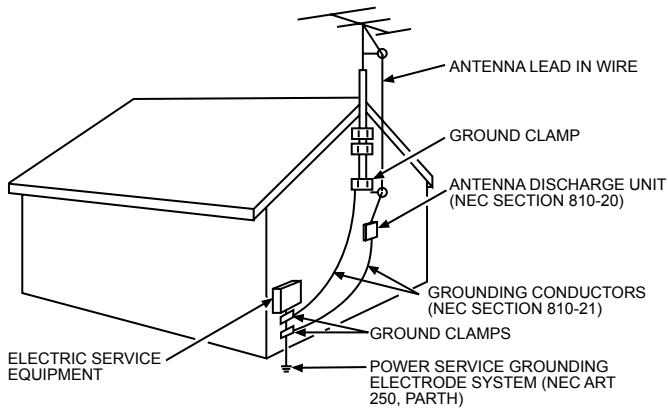

Table of Contents

Important Information	1	Geometry	15
Important Safety Instructions	2	Advanced Settings	15
Chapter 1 - Connections and Setup		Sound Menu	15
Before Initial Setup	4	Equalizer	15
Check Supplied Parts	4	SRS TruSurround HD	15
Attaching Your TV to the Table Stand	5	Speaker	15
Mounting Your TV to the Wall	5	SPDIF Type	15
Buttons on TV	6	Smart Volume	15
Explanation of Jacks on TV	6	MTS	15
Choose Your Connections	7	Audio Language	16
MHL Function	9	Setting Menu	16
Remote Control Functions	10	Language	16
Obtain the Signal	11	Channel	16
Switching On	11	Closed Caption	16
Switching Off	11	Parental Control	17
Setup Wizard	12	Time Setting	19
		Software Info.	19
Chapter 2 - Menu Operation		Location.	19
Menu Display	13	Restore to Default	19
Using Menu System	14	USB Menu	19
Input Menu	14	Chapter 3 - Other Information	
Picture Menu	14	Frequently Asked Questions (FAQs)	20
Picture Mode	14	Troubleshooting	21
Brightness	14	Care and Cleaning	23
Contrast	14	Television Specifications	23
Saturation	14	Limited Warranty	24
Sharpness	14		
Tint	14		
Color Mode	14		
Backlight	14		
Dynamic Backlight	14		
Dynamic Light Sensor	14		

Before Initial Setup

Protect Against Power Surges

- Connect all components before you plug any power cords into the wall outlet or power strip.
- NEVER plug your TV into an outlet that is controlled by a wall switch.
- Turn off the TV before you connect or disconnect any cables.
- Make sure all antennas and cables are properly grounded. Refer to the Important Safety Instructions.

Safety Information

- Protect components from overheating.
- Don't block ventilation holes on any of the components. Arrange the components so that air can circulate freely.
- Don't stack components.
- If you place the component in a stand, make sure you allow adequate ventilation.
- If you connect an audio receiver or amplifier, place it on the top shelf so the heated air from it won't harm other components.

Avoid Audio Interference

- Position cables properly; insert each cable firmly into the designated jack.
- If you place components above the TV, route all cables down one side of the back of the TV instead of straight down the middle.
- If your antenna uses 300-ohm twin lead cables, do not coil the cables.
- Keep twin lead cables away from audio/video cables.

Avoid Direct Light

Don't place the TV where sunlight or room lighting is directed toward the screen. Use soft or indirect lighting.

Check Supplied Parts

Check that the following parts were packed with your product.

- 1 Remote Control and 2 AAA Batteries
- User's Guide
- Quick Start Guide
- Parts for Table Stand

Replacing your remote

If you need to replace your remote, visit www.tclusa.com. A shipping and handling fee, and the appropriate sales tax, will be charged upon ordering. Have your Visa or MasterCard ready.

Connections and Setup

Attaching Your TV to the Table Stand

Your TV comes without the table stand attached so that you can choose to mount your TV either to its table stand or to a wall (wall mount sold separately). If you want to mount your TV to the wall, don't attach the table stand. Follow the Mounting Your TV to the Wall instructions.

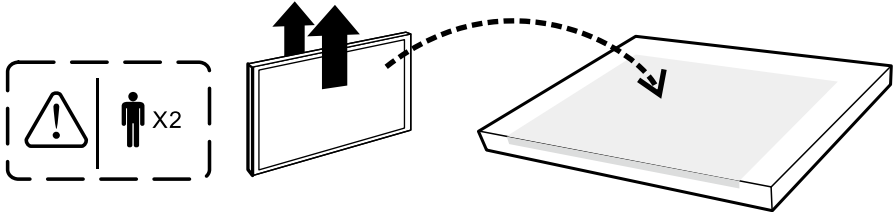

First, remove the TV bag and place it on a large, flat surface such as a table or countertop. Remove the TV from the carton and place it face down on the TV bag. Be sure that the TV is face down to avoid scratching the screen.

Then follow the steps below:

Note: A is applied to models of 50"; B is applied to models of 58". Keep the screws and plastic parts away from grease and organic solvents to avoid damage. Especially during the assembly process.

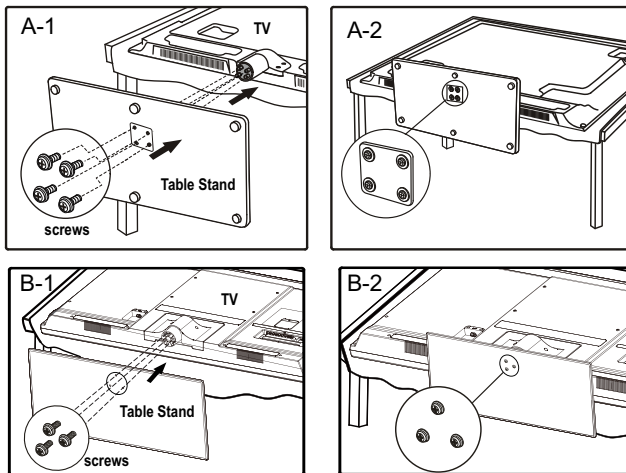

Mounting Your TV to the Wall

If you are mounting your TV to the wall, don't attach the table stand.

To mount your TV to the wall, purchase a VESA wall mount.

Models of 50"	Purchase a VESA 400 x 400, M6 screw
Models of 58"	Purchase a VESA 400 x 200, M6 screw

The VESA number is the horizontal and vertical measurement of the mounting holes. For example, 400x200 refers to the fact that the mounting measurements are 400mm horizontally and 200mm vertically.

Notes: Follow the directions included with the wall mount to mount the TV to the wall.

Caution: Your wall mount must be able to bear a minimum of five times the TV's net weight to avoid causing damage.

Connections and Setup

Buttons on TV

If you cannot locate your remote, you can use the TV panel buttons on your TV to operate many TV features.

- CH+/-** Selects channels stored in the channel list or acts as the up/down arrow (▲/▼) through the menu items.
- VOL+/-** Increases/decreases the volume or acts as the right/left arrow (◀/▶) through the menu items.
VOL+ also acts as the **OK** button when in the menu system.
- ≡ (MENU button)** Brings up the TV's main menu.
- ⏏ (INPUT button)** Selects the signal source.
- ⏻ (POWER button)** Turns the TV on or to standby mode.

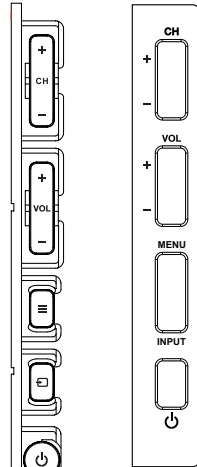

for 58" models
for 50" models

Explanation of Jacks on TV

This section describes the jacks on the side/back panel of your TV. There are several ways to connect components.



SPDIF OUT - DIGITAL AUDIO OUT (coaxial): Use a digital coaxial cable to connect your TV to a compatible audio receiver.

COMPONENT IN (CMPT): Lets you connect a component that has component video jacks, such as a DVD player or set-top box. (Green jack for Y, Blue jack for Pb and Red jack for Pr)

- **Y Pb Pr (Component Video):** Provides good picture quality because the video is separated into three signals. Use three video-grade or component video cables for the connection.
- **L/R AUDIO:** Provides left and right audio connection when using the CMPT VIDEO input. *Red and white jacks for R AUDIO and L AUDIO connection. (Note: AV IN and COMPONENT IN share the same L/R AUDIO and Y/Video input jacks.)*

AUDIO/VIDEO IN (AV IN): Lets you connect a component that has composite video jacks, such as a VCR, DVD player or set-top box. Green jack for VIDEO connection, red and white jacks for R AUDIO and L AUDIO connection.

VGA (PC VIDEO IN): Connect your computer or other component with a VGA output to this jack using a 15-pin, D-sub cable.

DVI/PC AUDIO IN (used for DVI/PC only): Provides audio connection when using HDMI/DVI INPUT 1 jack for DVI or when using PC VIDEO IN.

Note: If using a DVI component, remember to connect the audio cable because the DVI cable carries only the picture signal, not the sound.

ANT/CABLE/SAT IN: Lets you connect a coaxial cable to receive the signal from your antenna, cable, or cable box, or satellite receiver.

⏻ (HEADPHONE): Allow you to connect headphones to listen to the sound coming from the TV.

Connections and Setup

USB: Allows you to connect a compatible mass storage device.

HDMI 1 / DVI IN (High-Definition Multimedia Interface/Digital Visual

Interface): Provides an uncompressed digital connection that carries both video and audio data by way of an integrated mini-plug cable. Since HDMI technology is based on Digital Visual Interface (DVI), the jack on the back of your TV is also compatible with DVI components.

HDMI 2 (MHL) IN: Lets you connect a component, such as a digital cable or satellite box, with an HDMI output for the best picture quality.

MHL stands for Mobile High-definition Link, and allows you to link a MHL-capable mobile device to the television.

HDMI 3 IN: Lets you connect a component, such as a digital cable or satellite box, with an HDMI output for the best picture quality.



Choose Your Connections

There are several ways to connect components, such as BD player, DVD players and set-top boxes, to your TV.

Note: No cables are supplied with this unit. Please purchase the necessary cables. A high-speed HDMI cable is recommended for better compatibility.

Input	Signal Compatability
Antenna/Cable	480i, 480p, 720p, 1080i (NTSC, ATSC, and QAM formats)
Composite Video	480i
Component Video	480i, 480p, 720p/60Hz, 1080i/60Hz
HDMI	480i, 480p, 720p/60Hz, 1080i/60Hz, 1080p/60Hz
PC	VGA SVGA XGA SXGA WXGA

Connections and Setup

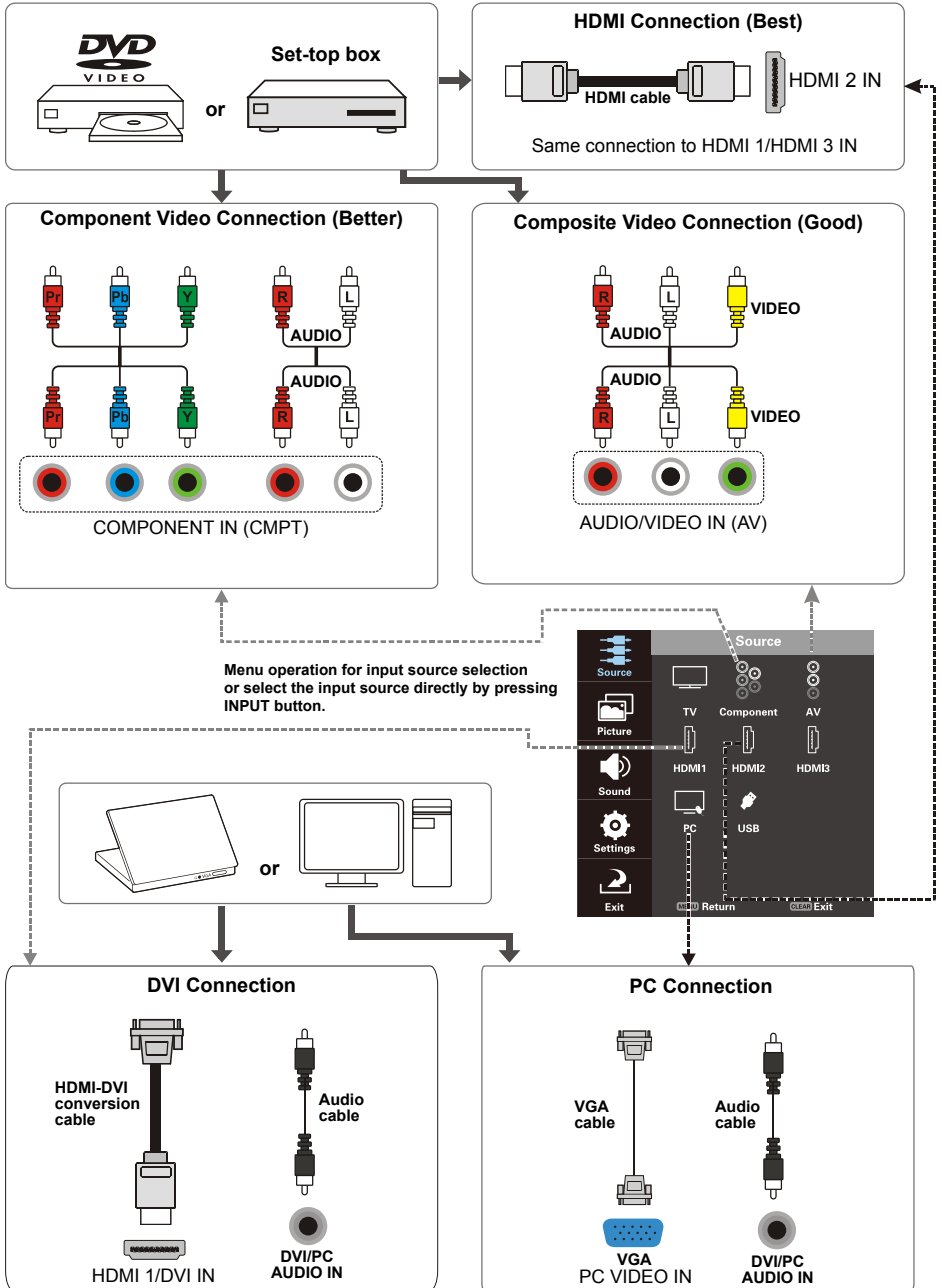

MHL Function (Mobile High-definition Link)

You can use the following functions by connecting between the TV HDMI 2 (MHL) port and the USB port of mobile phones etc. with an MHL cable.

- Charge with mobile phone from TV
- Two-way remote operation between TV and mobile phone
- Video/Audio output from mobile phone

Notes:

- *These functions may not be available depending on the connected equipment.*
- *If there is no more battery life left in the connected device, charging will not start.*

Connecting MHL-compatible Device

- Connect the MHL-compatible device to the HDMI 2(MHL) port on the TV using an MHL cable (not supplied), charging starts automatically.
- When connecting MHL-compatible device to HDMI 2(MHL) port on the TV, switch TV source to HDMI 2.

Note:

- *Do not connect the MHL-compatible device to any ports other than HDMI 2(MHL) port.*

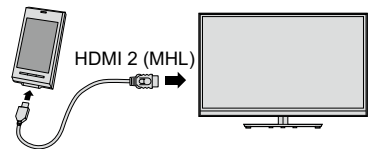

When using MHL

- Interoperability with MHL devices of other manufacturers is not guaranteed.
- TCL does not provide any guarantee, therefore, against operational failure such as that described below when an MHL source is connected to the TV.
 - No picture or sound
 - Some of the functions do not work by remote operation from the TV
- If the MHL does not work properly, also contact the manufacturer of the source device for advice on its use.
- Do not disconnect the power plug of the TV when the TV is active and the MHL device is being connected.
- Do not disconnect the power plug of the TV when the TV is in standby mode and the MHL device is being connected.

Remote Control Functions

- INPUT** Press **INPUT** repeatedly to select the video input
- 0-9** (Alphanumeric buttons) Enters a channel number, then press **OK** (or let the entry timeout).
- (dot) To enter a digital channel with a sub-channel, enter the main channel; then, press the dot (*), the sub-channel, and then the **OK** button.
- MENU** Brings up the main menu or press to return to the previous menu.
- ▲/▼ ◀/▶** (arrows) Highlights different items in the TV menu and adjusts the menu controls.
- ZOOM+/-** (◀/▶) Selects the desired screen format.
- SLEEP+/-** (▲/▼) Sets the TV to turn off after a given amount of time.
- PIC** Selects picture mode.
- INFO** If no menus are currently active, press **INFO** to display the Channel information.
- VOL+/-** Increases or decreases the TV volume.
- MUTE** Turns the volume on and off.
- FAV** Press the **FAV** button to browse the channels set in your favorite list. Use ▲/▼ to select one of the favorite channel to watch. Press **CLEAR** to exit the menu.
- MEDIA** Goes to the **USB** menu.
- ⏻** (**POWER** button) Turns the TV on or standby.
- GUIDE** Toggles the Electronic Programme Guide between on and off. Only available for digital channels.
- CLEAR** Removes any menu or display from the screen and return to normal viewing.
- OK** Displays Channel List menu. When the TV is in the menu system, press to confirm your selection.
- GO BACK** Returns you to the previously viewed channel.
- CH+/-** Selects channels and external input mode.
- TV** Press to access to the TV mode.
- MTS** Press to select your desired sound mode.
- ◀◀/▶▶/▶|** These buttons can be used for playing music and photos in the USB menu.
-



Obtain the Signal

The first step in connecting your TV is obtaining the signal. The back panel of your TV allows you to receive analog and/or digital channels by using the **HDMI** or **ANT/CABLE/SAT** connections. To obtain the best quality, use the **HDMI** connection.

Connect the outside aerial to the **ANT/CABLE/SAT IN** connection on the back of the TV to receive off-air channels. Use an **HDMI** connection to display the best picture and sound quality for satellite and cable

- If you have a set-top box, you may need to call your cable company or satellite service provider. They may recommend special cables to allow you to view digital channels.
- The aerial socket (75 OHM - VHF / UHF / cable) can be used for connecting an external aerial or other equipment fitted with a modulator (video recorder, satellite receiver, etc.). We recommend that you do not connect other equipment (video recorder, satellite receiver, etc.) to your TV set to begin with, so as not to complicate the set-up procedure with the additional steps involved. Connect them when you have finished setting up the channels.
- Visit www.antennaweb.org for help in deciding what type of antenna to use in order to receive the local digital channels available to you. Enter your location, and the program will list local analog and digital stations available using your antenna.

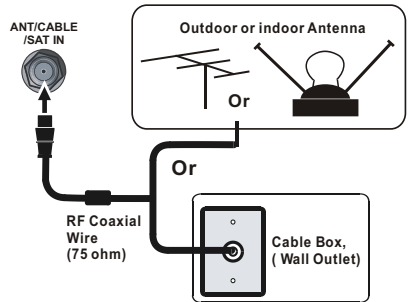

Switching On

Follow the instructions on this page on how to switch on your TV set and use the remote control before going on to following pages describing how to use the channel scan procedure.

1. Insert two AAA batteries in the remote control.

Precautions on using batteries:

- Only use the battery types specified.
 - Make sure you use the correct polarity.
 - Do not mix new and used batteries.
 - Do not use rechargeable batteries.
 - Do not expose batteries to excessive heat such as sunshine, fire or the like, throw them in a fire, recharge them or try to open them, as this could cause them to leak or explode.
 - Remove the batteries from the remote control if you are not using it for a long period of time.
2. Connect the power cable to a power outlet. (If the power cable is not connected to the television, please first connect the power cable to the television.) Your TV set should only be connected to an AC supply. It must not be connected to a DC supply. If the plug is detached from the cable, do not, under any circumstances, connect it to a power outlet, as there is a risk of electric shock.
 3. When powered on, if the TV set is in standby mode, press  on the remote control or on the TV set to turn on the TV.

Switching Off

To put the TV set into standby mode, press  on the remote control or on the TV, the TV set remains powered up, but with low energy consumption.

To disconnect power from the TV set, unplug the power cord from the power outlet.

Setup Wizard

Perform the following steps before you press  on the remote control unit.

- Insert the batteries into the remote control unit.
- Connect the antenna cable to the TV.
- Plug in the AC cord to the AC outlet.

The first time you switch the set on, the **Setup Wizard** opens, which guides you through the setup process.

1. The first step of the setup requires you to select your preferred language for the menu system. Press **▲/▼** to select your language, then press **OK** to enter the next screen.
2. A menu screen asks you to set the power on mode.
 - Choosing "Home Mode" for the TV assigns the optimal picture settings for most home environments.
 - Choosing "Retail mode", which is not ENERGY STAR compliant, sets the unit up with predefined settings for retail displays. In this setting, the power consumption may exceed the requirements of the ENERGY STAR® qualification.
1. Use **▲/▼** to select the desired location setting ("Home Mode" or "Retail mode"); then press **OK** to continue to the next screen.

Note: if you select "Retail Mode", a screen menu will display to ask you go back to the previous menu to select "Home Mode" by pressing **◀** to select **Go Back** and press **OK** to confirm , or you can select "Proceed" to proceed to the next screen.

2. Use **▲/▼** to select the current local time zone. Press **OK** to continue to the next screen.
3. Select either "Antenna" or "Cable/Sat" as the channel scan type. Press **OK** to begin the channel scan process.

Note: Make sure what kind of connection is made with your TV when selecting "Antenna" or "Cable/Sat".

4. The screen will change to show the progress of the channel scanning process, available channels will be stored in the TV's memory.

Note: If you do not want to scan for channels at this time, you can press **CLEAR** or **MENU** to exit the scanning process, and perform the channel scan later in the "Setting" menu.

If you are using a cable set-top box and connect using the RF connection, you do not have to complete the Channel Scan. You can simply tune to channel 3 or 4 on the TV, then use the remote that came with your cable/satellite box.

5. When the scanning is finished, the unit will switch to the first channel found.

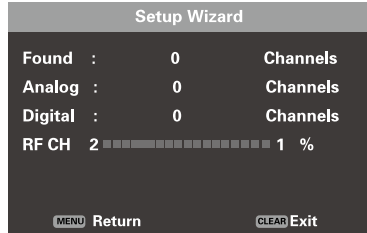
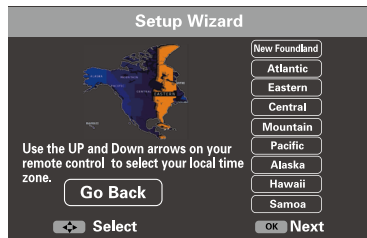
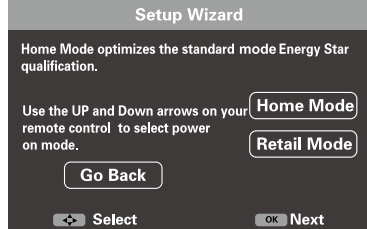
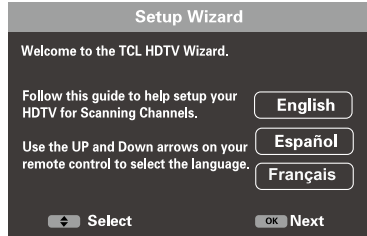

Menu Display

The following are just illustrations of the menu display. Some menu items may not be displayed depending on the selected input source.

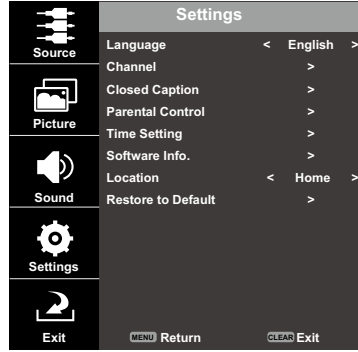
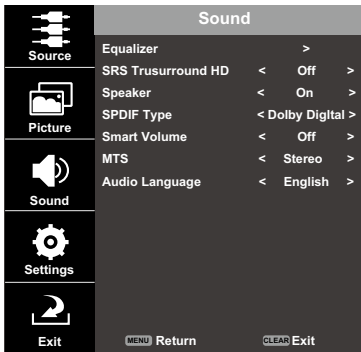
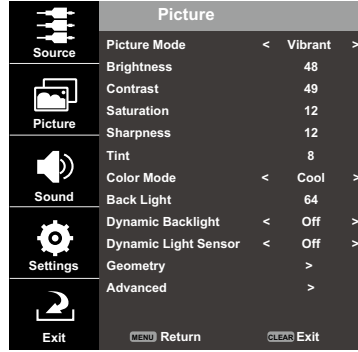
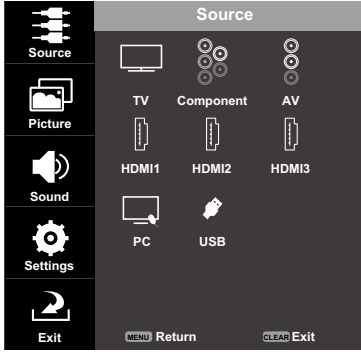

Using Menu System

This section explores the menus of your TV. Each menu is outlined and detailed to help you get the most from your TV. Example:

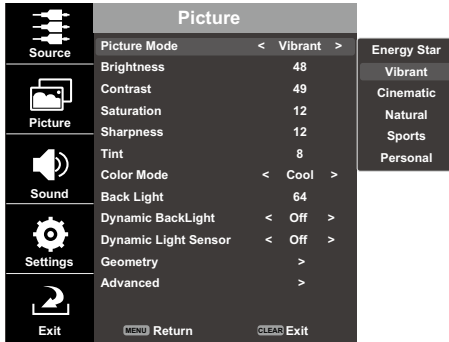

1. Press **MENU** to display the menu screen.
2. Press **▲/▼** to select the desired menu (selected item will turn to blue), then press **OK/▶** to enter.
3. Press **▲/▼** to highlight a specific adjustment item, and then press **◀/▶** to set functions or change values.
 - Additional related adjustment items may be displayed. Press **▲/▼/◀/▶** to select or adjust the desired item, if necessary press **OK** to confirm.
4. Press **MENU** to return to the previous menu or press **CLEAR** to close the menu.

Note: Operations vary depending on the function or item. Some menu items may not be displayed or may be displayed in grey (not selectable) depending on the selected input source.

Input Menu

The Input menu allows you to select the input source.

Press **MENU** to display the menu screen. Press **▲/▼** to select **Source**, then press **OK/▶** to display options. Press **▲/▼/◀/▶** to select the desired input source: " TV / Component/ AV / HDMI1 / HDMI 2 / HDMI 3 / PC / USB ". Press **OK** to confirm.

Picture Menu

The menus for adjusting the picture are used to obtain the best picture settings according to your preference, the type of program you are watching and the ambient lighting.

To access the "Picture" menu, press **MENU** to

display the menu screen. Press **▲/▼** to select "Picture", then press **OK/▶** to display options.

Picture Mode

Displays a list that lets you select one of the preset picture settings: "Energy Star, Vibrant, Cinematic, Natural, Sports, Personal." Choose the setting that best for your viewing environment.

Note: "Energy Star" makes this product qualify for ENERGY STAR, if you select some other options, the power consumption may change.

Brightness

Adjusts the brightness of the picture.

Contrast

Adjusts the difference between the light and dark areas of the picture.

Saturation

Adjusts the richness of the color.

Sharpness

Adjusts the crispness of the edges in the picture.

Tint

This option adjusts the balance between the red and green levels.

Color Mode

Adjusts the color temperature: "Normal, Warm and Cool".

Backlight

Adjusts the backlight level. the menu line is grayed out by default. Only when "Dynamic Backlight" and "Dynamic Light Sensor" are both set to "Off", the menu line can be adjustable.

Dynamic Backlight

This option automatically adjusts the brightness of the backlight according to the content of the incoming signal. "Dynamic Backlight" optimizes the picture quality and decreases power consumption.

Dynamic Light Sensor

When activated, this feature monitors the ambient light conditions in the room and adjusts the TV's backlight for optimum viewing. It also serves as an energy-saving feature by lowering the backlight power level when appropriate (typically in darker

conditions).

Note: When “Dynamic Light Sensor” or “Dynamic Backlight” is set to “Off”, the power consumption may exceed the requirements of the ENERGY STAR® qualification.

Geometry

This option allows you to adjust the PC settings when in PC mode.

Advanced Settings

Zoom Mode: Selects the desired screen format. The screen format may vary depending on the incoming signal.

3DNR (Noise Reduction): This setting reduces picture “static” or any type of interference. This feature is especially useful for providing a clearer picture in weak analog signal conditions. Choose between these options:

Auto for auto noise reduction adjustment.

Low for a softer, smoother picture that retains picture sharpness and detail.

Medium for a slightly softer picture than the Low setting.

High for an even softer, smoother picture than the other settings (the picture detail is somewhat decreased).

Off for no adjustment.

Film Mode – Select “On” to automatically detect a film-based source, analyzes it then recreates each still film frame for high-definition picture quality.

MEMC (only for model 58”) – This function provides more sharpness on moving pictures. Choose High level to keep the picture sharp at all times; however, very small details may fade a little at high speed. Choose Low or Middle levels to reduce the motion compensation. If Off is selected, this function is turned off.

Demo (only for model 58”) – selects the mode in which you want to demo the effect of motion enhancement, only available when MEMC is on. Options are: Left/Right and Up/Down.

Sound Menu

The “Sound” menu lets you adjust audio output. To access the “Sound” Menu, press **MENU** on the remote, and then use **▲/▼** to select “Sound”. Press **OK/▶** to enter. The following options will be displayed:

Equalizer

The five-band equalizer allows you to adjust the audio frequency settings. You can select one of the five preset options or create a custom preset.

Sound Mode: Allows you to choose a specific sound preset: “Standard, Music, Movie, Sports and Personal”.

Balance: Adjust the amount of audio sent to the left and right speakers.

Frequency Range: Choose a band and make adjustments. When making adjustments, the “Sound Mode” option automatically changes to “Personal”. Press **▲/▼** to select the desired frequency (100Hz, 300Hz, 1.5KHz, 5KHz, 10KHz) you wish to adjust. Use **◀/▶** to adjust the level.

SRS TruSurround HD

Option “On/Off”. When turned on, SRS renders premium virtual surround sound.

Speaker

Option “On/Off”. When you select the “Off” option, the sound speaker on the TV will be turned off.

SPDIF Type

This option controls the type of audio stream sent to the Digital Audio Output jack (**SPDIF OUT**). Available options are “Dolby Digital, PCM”.

Smart Volume

Option “On/Off”. This option reduces the annoying blasts in volume that often occur during commercial breaks, and also amplifies softer sounds in program material, eliminating the need for constant volume adjustment.

MTS

This option controls the manner in which the sound comes through your speakers. Options available vary according to the input selected.

Note: The MTS option is only available for analog channels.

Mono (available for regular TV viewing only):

This option plays the sound in mono only. Use this setting when receiving broadcasts with weak stereo signals.

Stereo: This option splits the incoming stereo audio signal into left and right channels. Most TV programs and recorded materials have stereo audio.

Second Audio Program (SAP): This option plays the program’s audio in a second language,

if available. SAP audio is broadcast in mono only. SAP is also used to broadcast a program's audio with descriptions of the video for the visually impaired.

Audio Language

Choose from the list of languages available for the program you're watching. The language chosen becomes your preferred language for all digital channels until you turn the TV off. If the language chosen is not being broadcasted with a program, the TV plays the default language for the program (usually "English" in the US).

Note: The "Audio Language" option is only available for digital channels.

Setting Menu

The "Settings" menu allows you to configure the TV with your preferences. Press **MENU** to display the menu screen. Press **▲/▼** to select "Settings"; then press **OK/▶** to display the following options:

Language

Select the OSD menu language from English, Spanish, or French.

Channel

Signal Source: Choose the signal source ("Cable/Sat" or "Antenna") you have connected to the **ANT/CABLE/SAT IN**.

Scan: When you perform a Channel Scan, your TV searches for channels with signals and stores the channel information in the Channel List. Then, as you watch TV and press **CH+** or **CH-**, your TV goes to the next or previous channel in the Channel List and skips the channels that do not have signals. If the TV signal source changes – for example, if you change from an outdoor antenna to cable TV – you will need to rescan for channels.

To automatically scan for channels:

1. After choosing a signal source, select **Setting > Channel > Scan**.
2. Press **OK/▶** to start the scan. You can see the search progress and how many channels are found in the on-screen menu. (**Note:** If you wish to stop the search, press the **CLEAR** button.)
3. After the scan is complete, press **MENU** to return to the previous menu, or press **CLEAR** to close the menu.

Favorite:

1. Select "Setting > Channel > Favorite", press **OK/▶** to enter, a list of available channels displayed.
2. Press **▲/▼** to select the desired channel, then press **OK** to set it as the favorite, and a heart icon appears to the right side of the channel indicating this channel already stored in the favorite channel list.
3. Set other favorite channels the same way.
4. You can easily select the favorite channel to watch using **FAV** and **▲/▼** buttons.

Show/Hide: You can hide channels in the Channel List. Then, when you press the **CH+** or **CH-** button, the TV will skip the hidden channels. You can still tune to these hidden channels by pressing the number of the channel on the numeric keypad.

To hide specific channels:

1. Select "Show/Hide", press **OK/▶** to open the submenu.
2. Press **▲/▼** to highlight the channel you wish to hide; then press **OK** to check the highlighted channel. You can add the channel back into the Channel List by highlighting it and un-checking it.
3. Repeat the process to hide additional channels.
4. Press **MENU** to return to the previous menu, or press **CLEAR** to close the menu.

DTV Signal: Show the condition of DTV signal: Good or Bad, Normal. Bad for no DTV signal or very weak DTV signal.

Closed Caption

Many programs are encoded with closed captioning information, which allows you to display the audio portion of a program as text on the TV screen.

Note: Closed caption settings are not available for **HDMI**, **CMPT** or **PC** inputs. These settings must be set in the connected component's menu. Closed captioning is not available on all channels at all times. Only specific programs are encoded with closed captioning information.

The Closed Caption options are:

CC Mode: This option allows you to choose the way closed captioning information appears on the screen.

CC Off - No captioning information displayed.

CC On - Chooses this option if you want captioning information to be shown whenever available.

CC On Mute - This option allows the closed captioning to display (when available) whenever

the TV's sound is muted. The captioning information is not displayed when the sound is not muted.

Analog CC Option: This option lets you select the captioning mode (CC1-CC4 or TEXT1-TEXT4) used for displaying caption information, when available. If you are unsure of the differences among the modes, you may prefer to leave the closed captioned mode set to CC1, which displays complete text of the program in the primary language in your area.

Digital CC Option: If available, this allows you to select a closed caption service mode (1-6) for digital channels.

CC Option

Mode - Select either "Default" or "Custom" options. "Custom" mode allows you to set the options below.

Font Style - Allows you to choose a character design for the digital closed caption text. A font is a complete assortment of letters, numbers, punctuation marks, etc. in a given design. You can choose from a variety of fonts.

Font Size - Allows you to set the size of the digital closed caption text.

Font Edge Style - Allows you to set edge style of the closed caption text.

Font Edge Color - lets you set the color of the closed caption text edge.

FG Color - Allows you to set the color of the digital closed caption text.

BG Color - Allows you to choose the color of the area of the screen behind the digital closed-caption.

FG Opacity - Allows you to sets the appearance of the digital closed caption text.

BG Opacity - Allows you to a set the appearance of the space behind the digital closed-caption text.

Parental Control

The choices in the US V-Chip and Canada V-Chip menus involve software inside your TV, referred to as V-Chip, which allows you to block TV programs and movies. TV programs can be blocked by age-based ratings, such as TV-MA. If available, TV programs can also be blocked by content, such as adult language (L). Movies can only be blocked by age-based ratings. Once you block programs, you can unblock them by entering a password. By default, the software inside your TV is turned off or

unlocked.

V-Chip reads the program's age-based rating (TV-MA, TV-14, etc.) and content themes (Violence (V), Adult Language (L), etc.). If you have blocked the rating and/or content themes that the program contains, you receive a message that the channel is currently blocked. Change the channel or to enter your password and temporarily deactivate the parental controls.

Broadcasters are not required to provide content themes, so programs received with no content themes are blocked only if you block their age-based rating. You can also block programs that have been given an Exempt rating, and programs that are considered unrated.

Change V-Chip Password

The first time you enter the Parental Control menu, you must enter the default secret code 0000 to adjust other parental control settings. Then set your individual password:

1. Select "Parental Control > Change Password", press **OK/▶** to enter.
2. Use the number buttons to enter the four-digit number for your password.
3. Re-enter the same code to confirm the password.

Note: *The password must be entered before the TV will continue with Parental settings next time. The super password is 2458, If you forget your password, enter it to override any existing password.*

System Lock

You must remember to set "System Lock" to On mode to have the following parental lock settings to take effect.

Input Lock

1. Select "Parental Control > Input Block", press **OK/▶** to display the Input source list screen.
2. Press **▲/▼** to select a input source, and press **◀/▶** to select to block or unblock the input. When you tune to the blocked input, you will need to enter a password to view it.

US V-Chip

Press **OK/▶** to display its submenus:

US V-Chip TV Ratings

You can automatically block all program ratings above a specified age-based rating level.

1. Select "Parental Control > US > TV Rating", press **OK/▶** to enter the US TV Ratings screen.

In the US TV Ratings panel you can customize the program blocking of the following TV ratings:

TV-Y	All children
TV-Y7	Children 7 years and older
TV-G	General audience
TV-PG	Parental guidance suggested
TV-14	Parents strongly cautioned
TV-MA	Mature audience only

You can also customize the TV ratings for the following content:

D	Sexual explicit dialog
L	Adult language
S	Sexual situations
V	Violence
FV	Fantasy violence

2. Press **▲/▼/◀/▶** to navigate through the TV rating options. Press **OK** to block or (unlocked).

US V-Chip Movie Ratings (MPAA)

You can automatically block all program ratings above a specified age-based rating level.

1. Select "Parental Control > US > MPAA", press **OK/▶** to enter the US Movie Ratings screen.

In the US Movie Ratings panel you can customize the program blocking of the following Movie ratings:

G	General audience
PG	Parental guidance suggested
PG-13	Unsuitable for children under 13
R	Restricted, under 17 requires accompanying parent or adult guardian
NC-17	No one under 17 admitted
X	Mature audience only

Canada English or French V-Chip Ratings

If you receive Canadian programs, you can block Canadian English and French V-Chip by ratings only. When you block a particular rating, you automatically block the higher-rated programs as well. To block Canadian English and French program ratings, follow these steps:

1. Select Parental Control > Canada, press **OK/▶** to enter the next screen.
2. Press **▲/▼** to select "Canada Eng or Cannada Fre". Press **OK/▶** to proceed.

Canadian English Ratings:

C	Children
C8+	Children 8 and older
G	General audience

PG	Parental guidance
14+	Viewer 14 and over
18+	Adult

Canadian French Ratings:

G	General audience
8 ans+	Viewer 8 and older
13 ans+	Viewer 13 and older
16 ans+	Viewer 16 and older
18 ans+	Adult

3. Press **▲/▼** to select the desired rating, and press **OK** to block or unblock it.

RRT Setting: Allows you to select the downloadable rating level. In the event that a new rating system is provided by the broadcaster, the new rating options would appear within this menu.

Reset RRT: Reset to the default RRT setting.

Unrated

The Unrated Ratings option lets you decide if programs that the V-Chip recognizes as unrated or exempt can be viewed. Unrated TV programs may include news, sports, political, religious, local and weather programs, emergency bulletins, public announcements, and programs without ratings. The Exempt option applies to both US and Canadian unrated programs and Canadian programs rated E.

1. Select Parental Control > Unrated.
2. Press **◀/▶** to toggle between **View** and **Block**.

View All unrated programs are available.

Block All unrated programs are not available.

Keyboard Lock

This option allows you to block (disable) or unblock (enable) the TV panel buttons. The remote control still tunes to any channel. If you are using this to keep children from changing channels, be sure to remove access to any remote that is capable of operating the TV while you have the TV panel button blocked. To block the TV panel buttons, select "Parental Control > Keyboard Lock", and press **◀/▶** to choose the "Block" option. To enable these buttons again, return to this menu and choose the "UnBlock" option.

Clear All

This option resets all settings (parental control settings) to the factory defaults. When you select this option, a confirmation box opens.

Time Setting

Time Zone

You can set the correct Time Zone for your area.

Auto Sync - Press ◀/▶ to choose **On** to acquire the time automatically from digital channels.

1. Select "Setting > Time Setup ", press **OK/▶** to proceed to the next screen.
2. Options on this screen include:

Clock - Only available when "Auto Synchronization" is set to "Off". Select "Clock" and press **OK** to enter, set the following time items:

Year - Press ▲/▼ to select "Year", press ◀/▶ to set the year. Using the same way to set "**Month, Day, Hour, Minute**". **PM/AM** will change automatically when you setting the time.

Sleep Timer- Press ◀/▶ to set the TV to turn off after a given amount of time.

DST (Daylight Saving) - Select **Auto** to set the daylight saving time for your area automatically.

Software Info.

This option allows you to see the software information such as software version, build time, panel and tuner information.

Location

This option allows you to select the desired location setting. Only Home mode is ENERGY STAR compliant.

Restore to Default

This option resets all settings (except parental lock settings) to the factory defaults.

1. Select "Setting > Restore to default", Press **OK/▶** to enter, and you must enter your password before proceeding to the next step.
2. Press ▲/▼ to select "Confirm" and press **OK** to confirm to reset all settings.

USB Menu

You can connect a device with USB to your TV or use a USB flash drive (only supports FAT, FAT32 and NTFS format USB device). This connection allows you to insert a USB flash drive directly or connect a compatible mass storage device with USB, such as a digital camera, a multi-format card reader, or an MP3 player. If you have a USB drive, plug it into the drive directly. If you have a device with a USB port, connect one end of the USB cable to the USB port and the other end to the USB jack on the side of the TV.

The USB feature on your TV allows you to play audio files (format supported: MP3) or display pictures (format supported: JPEG). To utilize this feature, follow these steps:

1. Press **MENU** to display the menu screen.
2. Use ▲/▼ to select "Source".
3. Press **OK/▶** to proceed enter.
4. Press ▲/▼/◀/▶ to select "USB", then press **OK** to enter. (Note: you also can access to the USB screen directly by pressing **MEDIA** button.)
5. Press ▲/▼ to select the Media Type: Photo or Music. Then press **OK** to proceed.
6. Select the connected disk, press **OK** to enter.
7. Press ▲/▼/◀/▶ to select, if select a Photo or music file, press **OK** to playback directly; If select a file folder, press **OK** to enter and press ▲/▼/◀/▶ to select a file and press **OK** to playback.
8. While playback photo or music, adjust as you like according to the operation guide icon on the bottom of the screen.
9. Press **CLEAR** to exit.

Frequently Asked Questions (FAQs)

What's the quickest way to view High Definition (HD) video?

Connect an off-air antenna to the ANT/CABLE/SAT IN to view free local digital channels. You may need to purchase an antenna.

Visit www.antennaweb.org for assistance in deciding what type of antenna to use to receive the local digital channels available to you. By entering your location, this mapping program tells you which local analog and digital stations are available using a certain antenna.

Are there other ways to view High Definition (HD) video?

Besides using an off-air antenna as mentioned above, you can also use a set-top box to receive digital video. Contact your cable company or satellite provider to purchase digital programming and have them connect the box to ensure you are viewing channels the best way.

How do I tell an analog channel from a digital channel?

Press the INFO button to display the Channel Banner. Look at the the screen. The dot (•) is displayed for a digital channel. If there is no dot, it is an analog channel.

Why are there bars on my screen and can I get rid of them?

Most digital video is sent in a 16/9 format which fills your screen, but is sometimes sent in 4/3 which does not fill your screen. It depends on how the station or device connected to your TV is formatting the video. If there are bars on the screen, press the ZOOM +/- button to try a different format that may eliminate the bars. Some bars can't be removed because of the way the format is sent by the broadcaster. The format changes as you press the ZOOM +/- button and the format type is displayed at the bottom of the screen.

Why does channel search find a lot of channels, but when I try to tune to them, there's nothing there?

Some channels enabled by the cable company don't carry programming, such as video ondemand. When channels are unavailable, your TV screen is blank or appears like snow. You probably want to remove these channels from your Channel List. Remove these in the Channel Skip Menu.

Why does the first channel search take a long time?

If you have both analog and digital channels, the TV is looking for all available channels in the Channel List. If you do have digital channels, the TV is also searching for scrambled channels, non-scrambled channels, and each sub-channel of that digital channel.

Why is my picture quality poor?

Use the HDMI connections on your TV to display the best picture quality. However, even using the HDMI, your content and content source will dictate the picture quality you see. For example, source content that is 1080p will show better than 720p or 480p.

Troubleshooting

Most problems you encounter with your TV can be corrected by consulting the following troubleshooting list.

TV Problems

The TV won't turn on.

- Make sure the TV is plugged in.
- Check the wall receptacle (or extension cord) to make sure it is "live" by plugging in another device.
- The TV panel controls may be locked (disabled). Use the remote control to unlock the TV panel controls.
- Select the Button Block feature on the Parental Control menu and press **OK** to uncheck the box.

There is no picture and no sound but the TV is on.

- You may be tuned to an input with no component connected to it. If you're trying to view a connected component, press **INPUT** until the picture from that component appears.
- The Signal Type option may be set incorrectly.
- The channel may be blank. Try changing channels.
- If you're watching your VCR and it's connected with coaxial cable to the **ANT/CABLE/SAT IN** jack, tune the TV to channel 3 or 4 (whichever channel is selected on the 3/4 switch on the back of your VCR). Also make sure the TV/VCR button on the VCR is in the correct mode (press the TV/VCR button on your VCR).

The sound is fine, but the picture is poor quality.

- If you're getting a black and white picture from a component you've connected to your TV, you might have your video cables connected to the wrong jacks. A yellow video cable connects to the yellow VIDEO INPUT jack on the side or back of your TV; three video cables or bundled component video cables (red, blue, and green) connect to the corresponding COMPONENT INPUT jacks on the back of your TV.
- Check the antenna connections. Make sure all of the cables are firmly connected to the jacks.

There is no sound, but the picture is fine.

- The sound might be muted. Try pressing the volume up button to restore sound.
- If using DVI or Y, PB, PR, remember to also connect the device's left and right audio output jacks to the TV's L and R AUDIO INPUT jacks.
- The sound settings may not be set correctly.

The screen is blank.

- Check your connections. If you used yellow, red, and white cables to connect, make sure they're connected to the red, white, and yellow AUDIO/VIDEO INPUT jacks on the side or back of the TV.
- If you're trying to watch something that's playing on a component connected to the TV (like a DVD), press INPUT until you get to the correct video input channel.
- Make sure the component connected to the TV is turned on.
- Try another channel.

The buttons on the TV panel don't work.

- The TV panel controls may be locked (disabled). Use the remote control to unlock the TV panel controls by selecting the Button Block feature in the Parental Control Menu and press ◀▶ to uncheck the box.
- Unplug the TV for 10 minutes and then plug it back in. Turn the TV on and try again.

The TV turns off unexpectedly.

- The electronic protection circuit may have been activated because of a power surge. Wait 30 seconds, and then turn the TV on again. If this happens frequently, the voltage in your house may be abnormally high or low.
- Unplug. Wait 10 minutes. Plug in again.

You can't select a certain channel.

- The channel may be blocked or not approved in the **Parental Control** Menu.
- If using a VCR, check to make sure the **TV/VCR** button on the VCR is in the correct mode (press the **TV/VCR** button on your VCR).
- Press the TV button and then try to change channels.

The stereo reception is noisy.

- It may be a weak station. Use the Sound Menu and Analog TV Sound to choose mono.

A black box appears on the screen.

- Closed captioning might be on. Check Closed Caption in the Setup menu.

You are having problems with the HDMI Connection.

- Make sure the HDMI or DVI component is turned on and the cables are firmly connected. If problems still occur, turn off your component and reconnect it. Reset the power by unplugging the power cord and plugging it back in.
- If you are tuned to the **HDMI 1**, or other **HDMI INPUT** and you're receiving Unusable Signal message screen, press the **INFO** button on the remote. If Acquiring Channel appears in the **Channel Banner**, the HDMI or DVI device isn't responding. Contact the manufacturer of the HDMI or DVI device for further assistance.
- If you tune to the **HDMI 1**, or other **HDMI INPUT** and you see snow, the video goes in and out, or the video takes a long time to appear, your HDMI or DVI component is having trouble sending video information to the TV. Reconnect your device. Reset the power by unplugging the power cord and plugging it back in. If problems persist, try connecting the Y Pb Pr jacks if they are available or contact the manufacturer of the HDMI or DVI component for further assistance.
- If you have black bars on each side of your picture, the component you connected might have a switch or a menu option allowing you to change the picture quality output that will fix this. Choose either 720p or 1080i.

The remote control doesn't work.

- Something might be between the remote and the remote light sensor on the front of the TV. Make sure there is a clear path.
- The remote may not be aimed directly at the TV.
- The batteries in the remote may be weak, dead, or installed incorrectly. Put new batteries in the remote.

The Universal Remote control doesn't work.

This TV utilizes new remote control signals and may not be compatible with your existing universal remote (e.g. satellite box remotes, cable box remotes, and generic universal remotes, etc.). Over time, newer universal remotes and set-top box equipment will become available that should pick up the new TV codes.

You are experiencing problems with V-Chip/Parental Controls.

If the rating limits don't work, you must lock the settings. Go to the Main Menu (press MENU on your remote), select **Parental Control > V-Chip > Rating Enable**, Rating Enable is highlighted. Press ◀/▶ to select On to have the rating limits take effect.

What else can I do?

If you've been through the Troubleshooting section and nothing has fixed your problem, try rebooting your TV. Note that after a reboot, you may need to run your TV through the setup process again. To do a reboot, unplug the power cord from the wall outlet or power strip. Keep your TV unplugged for about 5 minutes. Then plug in the TV and turn it on. See if the problem is fixed. If the problem remains, then please visit www.tclusa.com for updated FAQs or contact TCL Customer Support at the support number provided in your Warranty under "How To Get Service."

Care and Cleaning

Caution: Turn OFF your TV before cleaning.

You can clean the TV as required, using a soft lint-free cloth. Be sure to occasionally dust the ventilation slots in the cabinet to help assure adequate ventilation.

IMPORTANT: Never use strong cleaning agents, such as ammonia-based cleaners, or abrasive powder. These types of cleaners will damage the TV. The TV's screen may be cleaned with a soft, lint-free cloth as well. Take care not to scratch or mar the screen. If necessary, you may use a cloth dampened with warm water. While cleaning, do not spray liquid directly on the screen, or allow liquid to run down the screen and inside the TV. Also, never place drinks or vases with water on top of the TV. This could increase the risk of fire, shock hazard or damage to the TV.

Television Specifications

Broadcasting system	US System NTSC-M ATSC standard (8VSB), QAM
Receiving Channels	VHF2-13 UHF14-69 CATV 14-36 (A)-(W) 37-59 (AA)-(WW) 60-85 (AAA)-(ZZZ) 86-94 (86)-(94)95-99 (A-5)-(A-1) 100-135 (100)-(135) 01 (4A)
Tuner type	Frequency synthesized
Operating Temperature	5°C to 35°C (41°F to 95°F)
Operating Humidity	20% to 80%,non-condensing
Storage Temperature	-15°C to 45°C (5°F to 113°F)
Storage Humidity	10% to 90%,non-condensing

TTE Technology, Inc. (“TTE”) Limited Warranty

All LCD/LED Models

EXCEPT TO THE EXTENT PROHIBITED BY APPLICABLE LAW, THIS WARRANTY DOES NOT COVER, AND AS DESCRIBED BELOW TTE EXPRESSLY DISCLAIMS, ALL ACTUAL AND IMPLIED WARRANTIES WITH RESPECT TO ANY PRODUCT USED FOR INSTITUTIONAL OR OTHER COMMERCIAL PURPOSES (INCLUDING BUT NOT LIMITED TO RENTAL PURPOSES).

What your warranty covers: Defects in materials or workmanship to the original owner of this TCL product when purchased from an Authorized Dealer of TCL brand products and packaged with this warranty statement.

New LCD/LED Televisions

For how long after your purchase:

- Two (2) years from date of purchase for parts.
- Two (2) years from date of purchase for labor.

What we will do:

- At TTE’s discretion, pay an Authorized TCL Service Center for both labor charges and parts to repair your television, or replace your television with a new or refurbished/remanufactured unit. See “How to get service”.

How to get service:

- Call 1-877-300-8837. Please have your unit’s date of purchase, place of purchase and model/ serial number ready. The model/serial number information can be found on the back of your unit.
- A representative will troubleshoot your problem over the phone. If it is determined that your unit requires service, the service location will be at the sole discretion of TTE based upon the TTE Limited Warranty statement.
- At the sole discretion of TTE, television screen sizes 32” and smaller will either be repaired at an Authorized TCL Service Center or directly exchanged for a new or refurbished/remanufactured unit. At the sole discretion of TTE, television screen sizes 33” through 55” will either be repaired at an Authorized TCL Service Center or repaired in-home.

If repaired at an Authorized TCL Service Center, TTE is not responsible for transportation costs to the Authorized TCL Service Center. However, TTE will pay for return shipping. TTE will provide instructions for packaging and shipping the unit. Proof of purchase in the form of a bill of sale or receipted invoice from an Authorized Dealer which is evidence that the product is within the warranty period must be presented to obtain warranty service.

What your warranty does not cover:

- Customer instruction. (Your Owner’s Manual describes how to install, adjust, and operate your unit. Any additional information should be obtained from your Authorized Dealer.)
- Installation and related adjustments.
- Damage resulting from non-approved installation methods.
- Signal reception problems not caused by your unit.
- Damage from misuse or neglect.
- Batteries.
- A television that has been modified or incorporated into other products or is used for institutional or other commercial purposes (including but not limited to rental purposes).
- A unit purchased or serviced outside the USA.
- A unit sold as is or with all faults
- Acts of nature, such as but not limited to lightning damage.
- Special, incidental or consequential damages.

Product Registration:

Please register your TCL purchase on-line at www.tclusa.com. It will make it easier to contact you should it ever be necessary. Registration is not required for warranty coverage.

Limitation of Warranty:

- **THE WARRANTY STATED ABOVE IS THE ONLY WARRANTY APPLICABLE TO THIS PRODUCT. NO VERBAL OR WRITTEN INFORMATION GIVEN BY TTE TECHNOLOGY, INC., ITS AGENTS OR EMPLOYEES SHALL CREATE A GUARANTY OR IN ANY WAY INCREASE OR MODIFY THE SCOPE OF THIS WARRANTY.**
- **REPAIR OR REPLACEMENT AS PROVIDED UNDER THIS WARRANTY IS THE EXCLUSIVE REMEDY OF THE CONSUMER. TTE TECHNOLOGY, INC. SHALL NOT BE LIABLE FOR SPECIAL, INCIDENTAL OR CONSEQUENTIAL DAMAGES RESULTING FROM THE USE OF THIS PRODUCT OR ARISING OUT OF ANY BREACH OF ANY EXPRESS OR IMPLIED WARRANTY ON THIS PRODUCT. THIS DISCLAIMER OF WARRANTIES AND LIMITED WARRANTY ARE GOVERNED BY THE LAWS OF THE STATE OF CALIFORNIA. EXCEPT TO THE EXTENT PROHIBITED BY APPLICABLE LAW, ANY IMPLIED WARRANTY OF MERCHANTABILITY OR FITNESS FOR A PARTICULAR PURPOSE ON THIS PRODUCT IS LIMITED TO THE APPLICABLE WARRANTY AND WARRANTY PERIOD SET FORTH ABOVE.**

How State Law relates to this warranty:

- Some states do not allow the exclusion nor limitation of incidental or consequential damages, or limitations on how long an implied warranty lasts, so the above limitations or exclusions may not apply to you.
- This warranty gives you specific legal rights, and you also may have other rights that vary from state to state.

If you purchased your unit outside the United States or seek warranty coverage outside the United States: This warranty does not apply. Contact your dealer for warranty information.

Service calls which do not involve defective materials or workmanship are not covered by this warranty. Costs of such service calls are the sole responsibility of the purchaser.



This product incorporates HDMI technology. HDMI, the HDMI logo, and High-Definition Multimedia Interface are trademarks or registered trademarks of HDMI Licensing LLC.



Plug in an MHL-compatible mobile device to view your favorite content and charge your device at the same time.



ENERGY STAR is a set of power-saving guidelines issued by the U.S. Environmental Protection Agency (EPA).

ENERGY STAR is a joint program of the U.S. Environmental Protection Agency and the U.S. Department of Energy helping us all save money and protect the environment through energy efficient products and practices.



Manufactured under license from Dolby Laboratories.

“Dolby” and the double-D symbol are registered trademarks of Dolby Laboratories.



SRS TruSurround HD is a trademark of SRS Labs, Inc. TruSurround HD technology is incorporated under license from SRS Labs, Inc.

SRS TruSurround HD™ creates an immersive, feature-rich surround sound experience from two speakers, complete with rich bass, high frequency detail and clear dialog.

FCC Information

This equipment has been tested and found to comply with the limits for a Class B digital device, pursuant to Part 15 of the FCC Rules. These limits are designed to provide reasonable protection against harmful interference in a residential installation. This equipment generates, uses, and can radiate radio frequency energy and, if not installed and used in accordance with the instructions, may cause harmful interference to radio communications. However, there is no guarantee that interference will not occur in a particular installation. If this equipment does cause harmful interference to radio or television reception, which can be determined by turning the equipment off and on, the user is encouraged to try to correct the interference by one or more of the following measures:

- Reorient or relocate the receiving antenna.
- Increase the separation between the equipment and receiver.
- Connect the equipment into an outlet on a circuit different from that to which the receiver is connected.
- Consult the dealer or an experienced radio/TV technician for help.

This Class B digital apparatus complies with Canadian ICES-003.

Please do not send any products to the California address listed in this manual or on the carton. This will only add delays in service for your product.

Figures and illustrations in this User's Guide are provided for reference only and may differ from actual product appearance. Product design and specifications may be changed without notice.



TTE Technology, Inc.

555 S. Promenade Ave., Suite 103, Corona, CA 92879

TCL and associated marks are trademarks of TCL S.A. used under license to TTE Corporation.

Part No.: 72-58MS39-XNA1B